

01	08-02-0460
PL	obejma górna
D	halter
GB	top clamp

02	07-17-0135
PL	ramię lewe łukowe
D	Arm links gebogene
GB	arm left curved

03	07-17-0134
PL	ramię prawe łukowe
D	arme rechts gebogene
GB	arm right curved

04	05-01-0719
PL	guma 45mm
D	Gummi 45mm
GB	rubber 45mm

05	05-01-0711
PL	guma 50mm
D	Gummi 50mm
GB	rubber 50mm

06	07-02-0215
PL	śruba M16
D	Schraube M16
GB	bolt M16

07	07-12-0030
PL	podkładka HLM
D	Pad HLM
GB	washer HLM

08	07-07-0037
PL	nakrętka M16
D	Mutter M16
GB	nut M16

09	05-02-0616
PL	osłona śruby M16
D	Kunststoffkappe
GB	PVC cap

10	07-02-0137
PL	podkładka
D	Pad
GB	washer

11	07-02-0136
PL	śruba
D	Schraube
GB	bolt

12	05-02-0127
PL	talerz uzębiony 560 mm
D	Scheibe gezakte 560 mm
GB	notched disc 560 mm

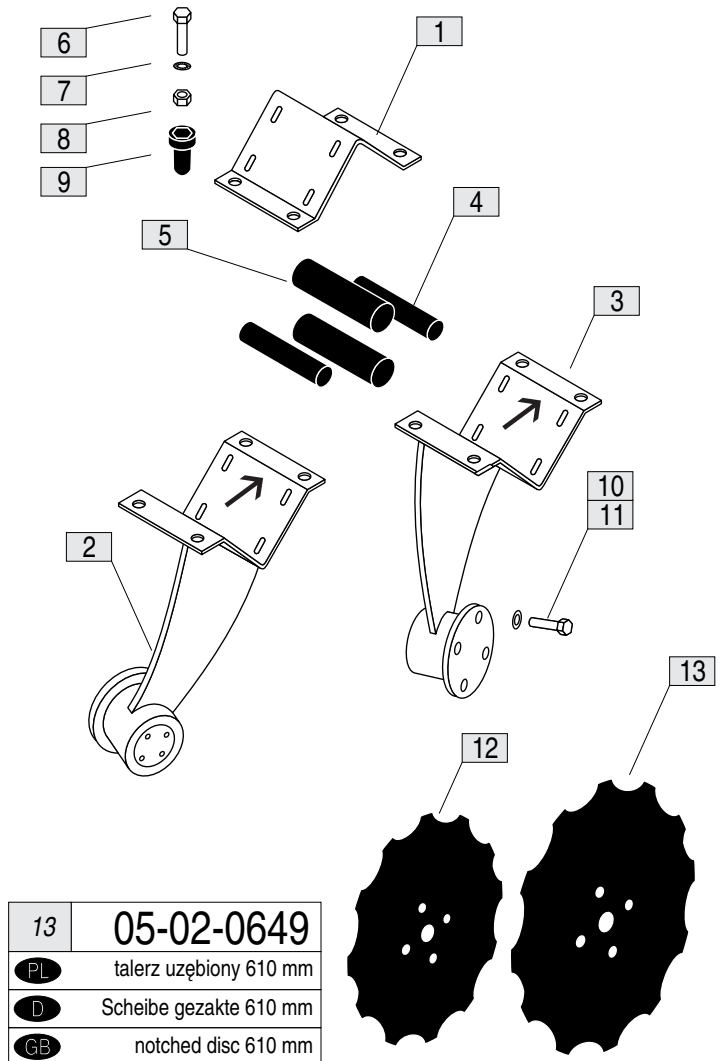

00	05-02-0487
PL	talerz obrysowy 465mm
D	Seitenscheibe 465mm
GB	border disc 465mm

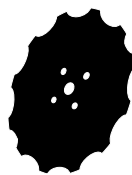

00	05-02-0689
PL	talerz obrysowy P 560mm
D	Seitenscheibe R 560mm
GB	border disc R 560mm
ⓘ	GAL 2,5/3,0/4,0

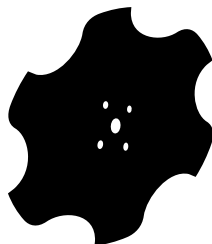

00	05-02-0690
PL	talerz obrysowy L 560mm
D	Seitenscheibe L 560mm
GB	border disc L 560mm
ⓘ	GAL 4,0H/5,0H/6,0H

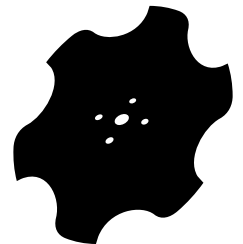

00	06-04-0008
PL	blokada siłownika (kpl)
D	Blockade (Satz)
GB	lockout (set)
i	GAL-H

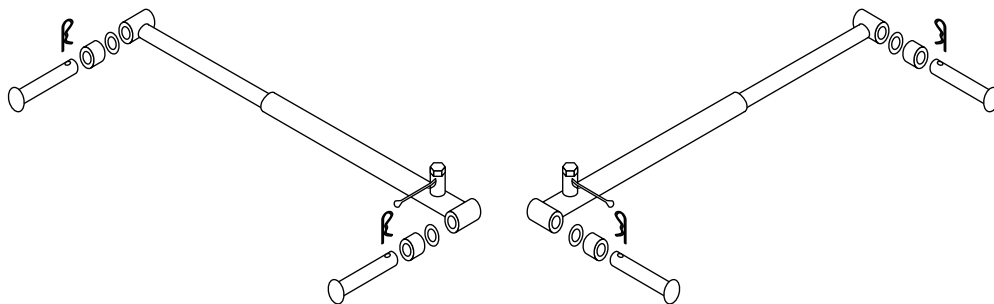

00	06-01-0018
PL	siłownik składania ramy
D	Seitenrahmenzylinder
GB	side frame piston
i	GAL-H

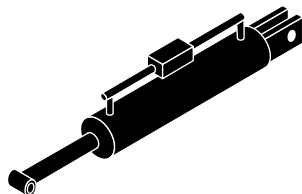

00	15-01-0517
PL	plytka
D	platte
GB	plate
i	GAL-C / GAL-H

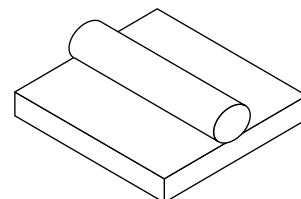

00	05-02-0005
PL	zawleczka z kółkiem
D	keil mit ring
GB	cotter with ring

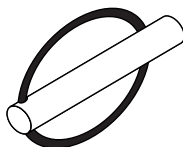

00	20-20-0004
PL	sworzeń drabinki
D	bolze
GB	pin
i	GAL-C / GAL-H

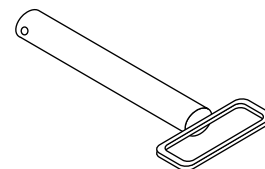

00	20-01-0013
PL	sworzeń górny
D	top stift
GB	top bolt
i	GAL 2,5 / 3,0 / 4,0

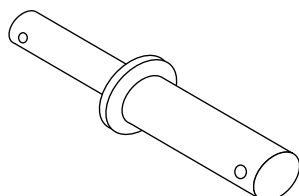

00	20-28-0001
PL	sworzeń dolny
D	unten stift
GB	lower bolt
i	GAL 2,5 / 3,0 / 4,0

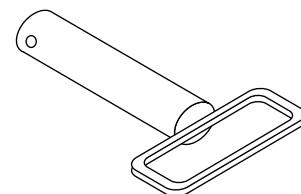

00	20-01-0008
PL	sworzeń górny
D	top stift
GB	top bolt
i	GAL 4,0H / 5,0H / 6,0H

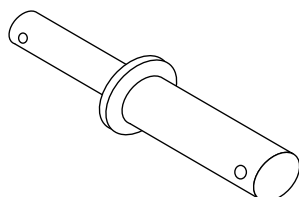

00	20-01-0005
PL	sworzeń dolny
D	unten stift
GB	lower bolt
i	GAL 4,0H / 5,0H / 6,0H

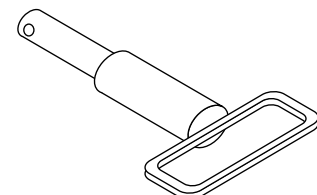

00	07-17-0001
PL	łożysko wału rurowego
D	Rohrstabwalze Lagerung
GB	tubular roller bearing



00	07-17-0117
PL	łożysko wału V-/ T-/C-ring
D	Lagerung V-/ T-/C-ring Walze
GB	bearing V-/ T-/C-ring rollers

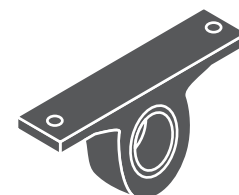

01a	15-01-0962R
PL	uchwyt lewy
D	Halter links
GB	holder left

01b	15-01-0962P
PL	uchwyt prawy
D	Halter rechts
GB	holder right

02	07-07-0005
PL	nakrętka
D	Mutter
GB	nut

03	07-02-0082
PL	śruba
D	Schraube
GB	bolt

04	15-01-1040
PL	blacha boczna długa
D	lange Seitenblech
GB	side screen long

